

WEY KNIFE GATE VALVE W3 AIR CYLINDER OPERATED



Data sheet

Size 2"-36" Standard Configuration

- Design: Full Flange Body
- Materials: Solid Cast Body
Hardened 17.4 pH Gate
- Solid Steel Heavy Duty Bonnet Topworks
- Flange Drilling: ANSI 300
Flange bolt threads per ASME B16.5 and ASME B16.47
- Face-to-Face: MSS-SP135
- Pressure Rating: Size 2"-36" 640 psi Shut-off
Higher Pressure Ratings Available
- Lager Sizes Available on Request
- Suitable for Dead-end Service
- Optional Cylinder Sizes Available

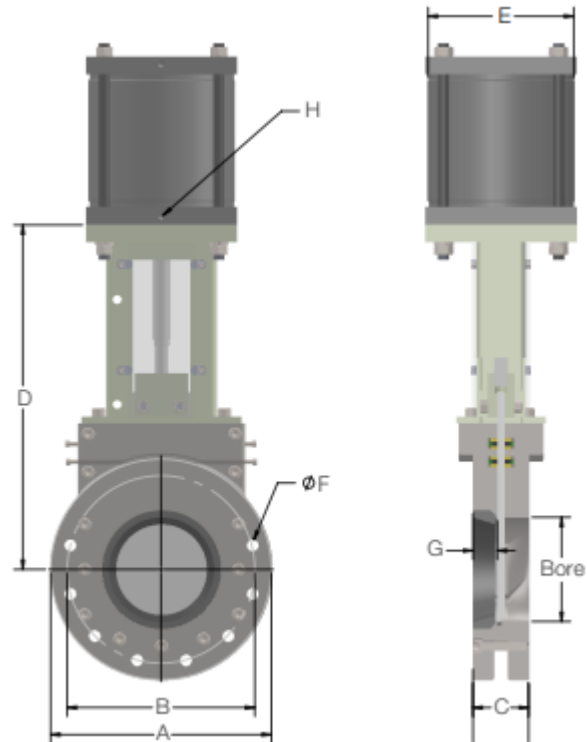

Bore	A	B	C	D	E	F	G	H	Bolts	⊕	Op. Pressure	Weight
2"	6.50	5.00	2.75	9.12	-	5/8" - 11	0.63	-	8 pcs.	2	640 psi	-
3"	8.25	6.62	2.75	12.16	-	3/4" - 10	0.75	-	8 pcs.	2	640 psi	-
4"	10.00	7.88	2.75	14.25	-	3/4" - 10	0.75	-	8 pcs.	2	640 psi	-
6"	12.50	10.63	3.15	19.26	-	3/4" - 10	0.86	-	12 pcs.	4	640 psi	-
8"	15.00	13.00	3.50	22.93	-	7/8" - 9	1.12	-	12 pcs.	4	640 psi	-
10"	17.50	15.25	4.68	26.11	-	1" - 8	1.02	-	16 pcs.	6	640 psi	-
12"	20.50	17.75	5.00	31.71	-	1 - 1/8" - 8	1.18	-	16 pcs.	6	640 psi	-
14"	23.00	20.25	5.50	36.42	-	1 - 1/8" - 8	1.34	-	20 pcs.	6	640 psi	-
16"	25.50	22.50	5.50	37.60	-	1 - 1/4" - 8	1.34	-	20 pcs.	6	640 psi	-
18"	28.00	24.75	6.25	44.07	-	1 - 1/4" - 8	1.34	-	24 pcs.	8	640 psi	-
20"	30.50	27.00	7.44	47.15	-	1 - 1/4" - 8	1.26	-	24 pcs.	8	640 psi	-
24"	36.00	32.00	8.50	56.13	-	1 - 1/2" - 8	1.22	-	24 pcs.	8	640 psi	-
26"	38.25	34.50	8.50	59.40	-	1 - 5/8" - 8	1.57	-	28 pcs.	10	640 psi	-
28"	40.75	37.00	10.00	62.59	-	1 - 5/8" - 8	1.97	-	28 pcs.	10	640 psi	-
30"	43.00	39.25	10.50	69.15	-	1 - 3/4" - 8	1.97	-	28 pcs.	10	640 psi	-
36"	50.00	46.00	12.00	79.78	-	2" - 8	2.16	-	32 pcs.	12	640 psi	-

E = Consult the Factory for Custom Cylinder. Sizing to fit your Specific Application.

F = Bolt Diameter & Thread Pitch

H = Cylinder Ports NPT

⊕ = Number of Blind Tapped Holes in Chest

All information for reference only.
Modifications reserved.